



# MISCELATORE / MIXER Art.F05

# FLY/SKY

## Descrizione / Description

Miscelatore monocomando da incasso per doccia con deviatore

Concealed shower mixer with diverter

## Caratteristiche Tecniche

Cartuccia a dischi ceramici: Ø35

Trattamento superficiale: cromato







## Technical Features

Cartridge ceramic discs: Ø35

Surface treatment: chrome-plated







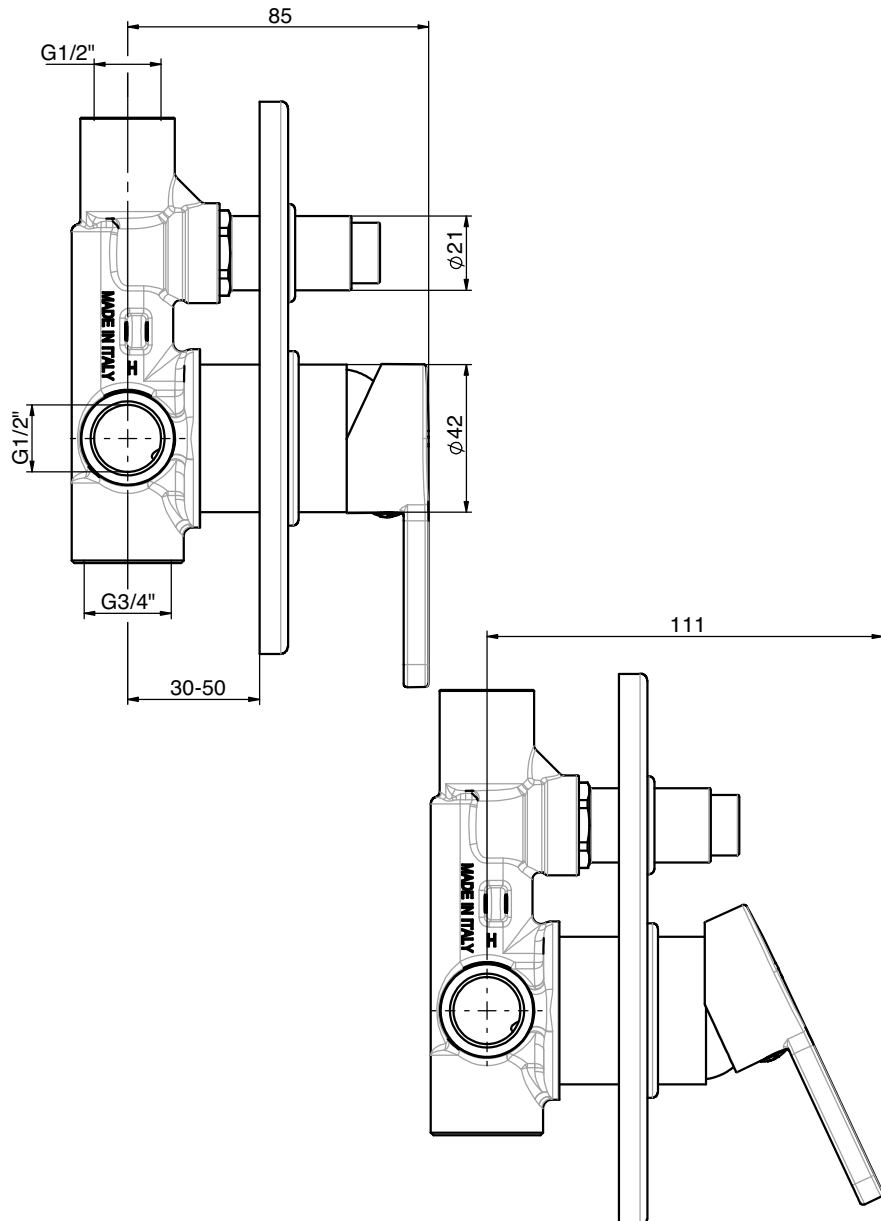
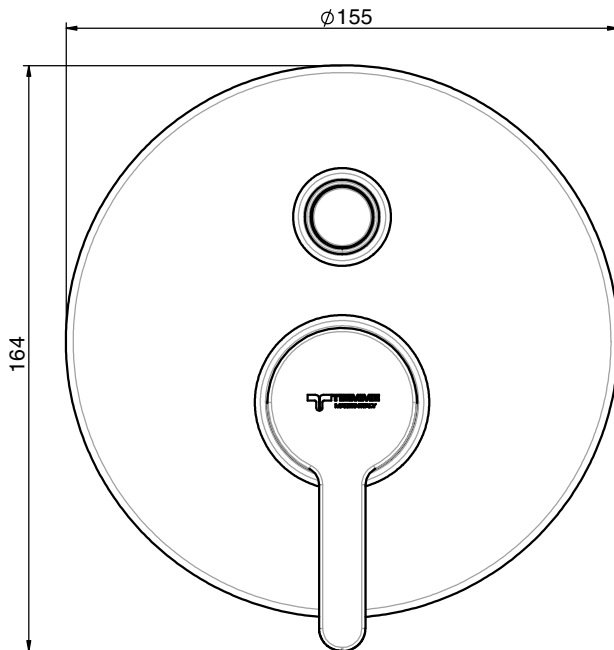

## Finiture leva Lever finishings

	Cromo Chrome		Grigio platino Platinum Grey <b>PG1 - RAL 7036</b>
	Bianco White <b>W1 - RAL 9003</b>		Blu Night blue <b>NB1 - RAL 5026</b>
	Nero Black <b>B1 - RAL 9004</b>		Verde acqua Water blue <b>WB1 - RAL 5021</b>

## Dimensioni Dimensions





Modello Model	Codice Code	Codice Prodotto Product Code	Descrizione Description	Finitura Finishing
FLY 	F05	411490402	Miscelatore monocomando da incasso per doccia/ vasca con deviatore 2 uscite	Concealed bath/shower mixer with 2 outlets diverter  CROMO
FLY 	F05 W1	411490408	Miscelatore monocomando da incasso per doccia/ vasca con deviatore 2 uscite, con leva colorata	 RAL 9003
	F05 B1	411490405		 RAL 9004
	F05 NB1	411490406		 RAL 5026
	F05 PG1	411490407		 RAL 7036
	F05 WB1	411490409		 RAL 5021



## Accessori Accessories



cod. 411520404

**TIEMME Raccorderie S.p.A.**  
Via Cavallera 6/A (Loc. Barco) - 25045 Castegnato (Bs) - Italy  
Tel +39 030 2142211 R.A. - Fax +39 030 2142206  
info@tiemme.com - www.tiemme.com

TIEMME Raccorderie S.p.A. si riserva di apportare modifiche in qualsiasi momento senza preavviso. È vietata qualsiasi forma di riproduzione, se non autorizzata.  
TIEMME Raccorderie S.p.A. reserves the right to modify contents in any time without prior advise. Is forbidden any reproduction unless under TIEMME authorization