

Grant EZ-Fit Flue Guide

Universal EZ-Fit Flue Systems
to suit all Grant Condensing Boiler Ranges



All Grant
flues
are now
CE mark
approved



BALANCED FLUE SYSTEMS

YELLOW SYSTEM, WHITE SYSTEM,
GREEN SYSTEM, RED SYSTEM

CONVENTIONAL FLUE SYSTEMS

ORANGE SYSTEM, GREEN SYSTEM,
BLUE SYSTEM

CLEARANCES AND DESIGN SERVICE
GUIDE TO FLUE CLEARANCES

January 2017



EFFICIENT HEATING SOLUTIONS

ROUND LOW LEVEL BALANCED FLUE SYSTEMS

- Stainless Steel -

LOW LEVEL EZ-FIT FLUE KITS 'YELLOW SYSTEM'

Grant's latest range of EZ-Fit flue Systems have been developed to make the installation of Grant boilers both quick and simple, whilst ensuring trouble free operation – even in the most exposed site conditions.

REDUCES INSTALLATION TIME

The round low level kits feature self-sealing ducts requiring no silicone or tape for joints, and the unique quick-fit clamp arrangement ensures a perfect seal every time. In fact, the new telescopic flue system requires only two simple operations to complete the installation. The kits are compatible with all Grant boilers, (except Outdoor Modules) including condensing models.

THE GRANT FLUE TERMINAL

The flue terminal has a compact design, making it ideal for installations where the visual appearance is important. The new cone design reduces the possibility of condensate, produced in the combustion process, staining external wall surfaces or patio slabs.

BOILER HOUSE MODELS

Grant EZ-Fit round low level balanced flue kits are also compatible with all Grant boiler house models. An Adaptor Kit, **Part No. EZAS** is supplied with the burner. This kit contains a snorkel tube and a spring clip.

EXTENSION KITS

The flue kits are telescopic and available in standard options. For wall thicknesses greater than shown, three extensions are available which extend the flue by 225mm, 450mm or 675mm. 90° and 45° elbows are also available to give a greater degree of flexibility when siting the boiler.

LOW LEVEL FLUE KIT WITH 90° ELBOW EXTENSION ADDED

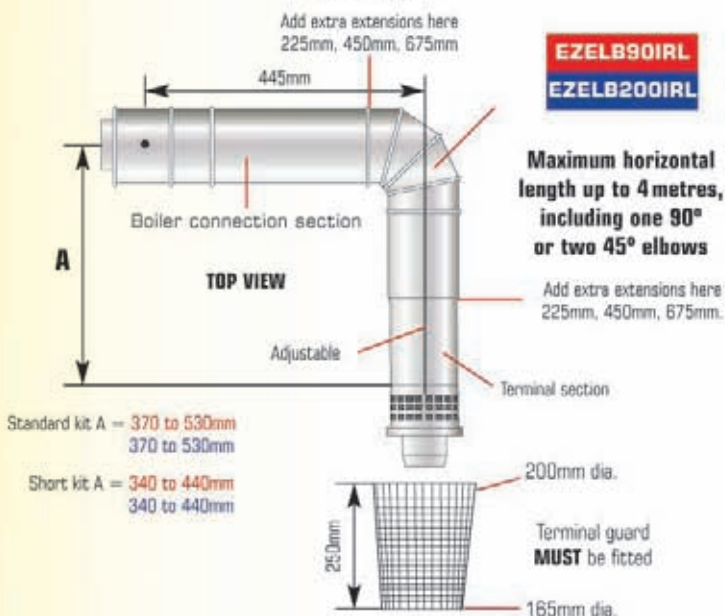

LOW LEVEL FLUE KITS [STAINLESS STEEL]

| | | | |
|-------------------|-----------------------------------|----------------|-------------------------------------|
| Standard Flue Kit | EZ90IRL EZ200IRL | Short Flue Kit | EZ90SIRL EZ200SIRL |
|-------------------|-----------------------------------|----------------|-------------------------------------|

NOTE: For Boiler House models, air supply kit part No. **EZAS** is supplied with boiler.



Contents of low level flue kit:

Boiler connector section
Terminal section
Stainless steel flue guard

Dress plate (not shown)
Plugs and screws
Fixing clamp and gasket.

Side outlet cover trim (not shown)
Lubricant (not shown)
Snorkel clamp (not shown)

LOW LEVEL BALANCED FLUE HOLE CUTTING DIMENSIONS

| | MODEL | DIMENSIONS (mm) | | |
|----------------|--|-----------------|-----|-----|
| | | A | B | C |
| NON-CONDENSING | Euroflame Kitchen/Utility models 50/70 | 718 | 85 | 127 |
| | Euroflame Kitchen/Utility models 50/90 & 50/90 System | 769 | 105 | 127 |
| | Euroflame Kitchen/Utility models 90/120 & System | 735 | 115 | 155 |
| | Euroflame Boiler House models 50/70 | 748 | 95 | 127 |
| | Euroflame Boiler House models 50/90 | 769 | 120 | 127 |
| | Euroflame Boiler House models 90/120 | 783 | 126 | 155 |
| | Multi Pass Kitchen & System models 70/90 | 756 | 125 | 127 |
| | Multi Pass Kitchen & System models 90/140 | 950 | 130 | 162 |
| | Multi Pass Kitchen models 140/160, 160/200 | 1065 | 155 | 162 |
| | Multi Pass Boiler House models 70/90 | 754 | 150 | 127 |
| | Multi Pass Boiler House models 90/140 | 948 | 140 | 162 |
| | Multi Pass Boiler House models 140/160 & 160/200 | 1063 | 150 | 162 |
| CONDENSING | Internal Combi models 90 & Max | 756 | 115 | 127 |
| | Vortex Kitchen model 50-70 (15-21) | 768 | 127 | 115 |
| | Vortex Kitchen, Boiler House & System models 50-80 (15-28) | 768 | 127 | 115 |
| | Vortex Kitchen, Boilerhouse & System models 90-120 (28-36) & 126-155 (36-48) | 780 | 162 | 115 |
| | Vortex Kitchen, Boilerhouse models 155-200 (48-58) & 200-240 (58-70) | 1105 | 115 | 162 |
| | Vortex Condensing (Internal) Combi model 26 (90) | 768 | 115 | 127 |
| | Vortex Condensing (Internal) Combi model 36 (120) | 780 | 105 | 162 |
| | Euroflame Condensing Kitchen & Boiler House 50/70 & 70-90 | 768 | 115 | 127 |
| | Euroflame Condensing Kitchen & Boiler House 90-120 | 780 | 115 | 162 |

Note: Dimension 'B' is given with the boiler pushed back against the rear wall. Any clearances must be added to 'B'.

Note: Flue diameters:
123mm
152mm

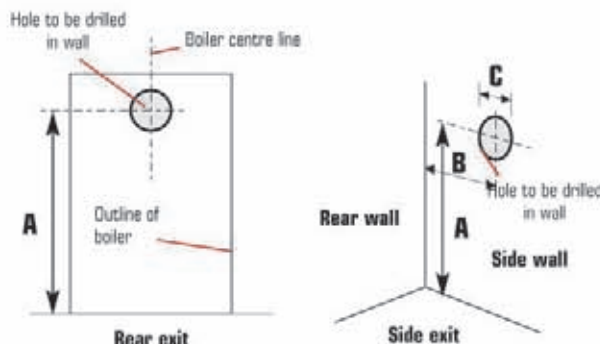

NOTE: Core drill sizes – Models up to 26kW (90,000Btu/h) **127mm**. Remaining models from 26 to 70kW (90-240,000Btu/h) **162mm**.

ORDER PART REFERENCE GUIDE

LOW LEVEL BALANCED FLUE KITS

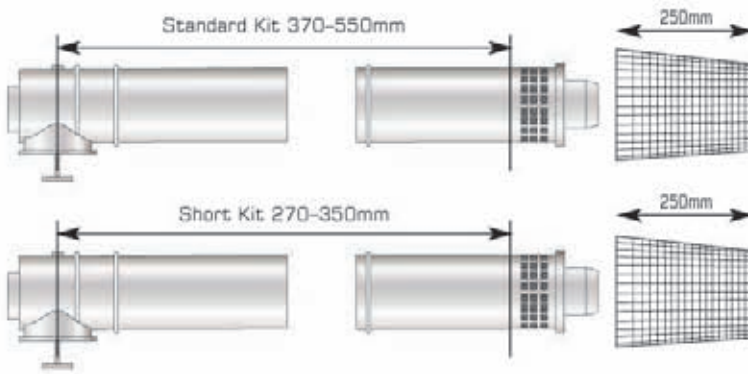

| | | |
|-------------------|------------------|-------------------|
| Standard Flue Kit | EZ90IIRL | Models up to 26kW |
| | EZ200IIRL | Models 26 - 70kW |

| | | |
|----------------|------------------|-------------------|
| Short Flue Kit | EZ90SIRL | Models up to 26kW |
| | EZ200SIRL | Models 26 - 70kW |

LOW LEVEL BALANCED FLUE EXTENSIONS & ACCESSORIES

IMPORTANT

FLUE EXTENSIONS CANNOT BE CUT. YELLOW SYSTEM EXTENSIONS ARE FOR HORIZONTAL USE ONLY AND CANNOT BE USED VERTICALLY WITH GREEN, ORANGE OR WHITE SYSTEM COMPONENTS.



| | | |
|-----------------|-----------------|-------------------|
| Extension 225mm | X90SIRL | Models up to 26kW |
| | X200SIRL | Models 26 - 70kW |



| | | |
|-----------------|-----------------|-------------------|
| Extension 450mm | X90MIRL | Models up to 26kW |
| | X200MIRL | Models 26 - 70kW |

IMPORTANT

HORIZONTAL LENGTHS UP TO 4 METRES CAN BE ACCOMMODATED, INCLUDING ONE 90° OR TWO 45° ELBOWS.



| | | |
|-----------------|-----------------|-------------------|
| Extension 675mm | X90LIRL | Models up to 26kW |
| | X200LIRL | Models 26 - 70kW |

IMPORTANT

EXTENDED ELBOWS ALLOW TELESCOPIC ADJUSTMENT FOR EXTENSIONS OR TERMINAL SECTIONS.

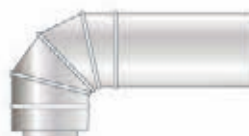

| | | |
|---------------|---------------------|-------------------|
| 90° Elbow Kit | EZELB90IIRL | Models up to 26kW |
| | EZELB200IIRL | Models 26 - 70kW |

SINGLE WALL FLUE KIT STAINLESS STEEL

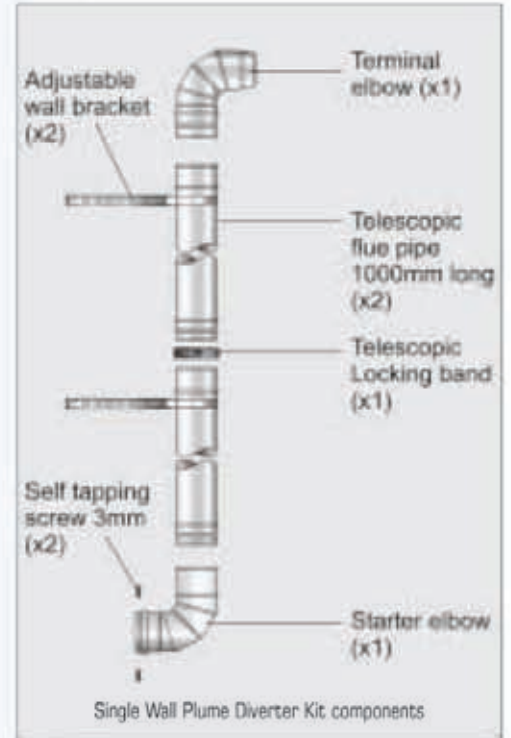
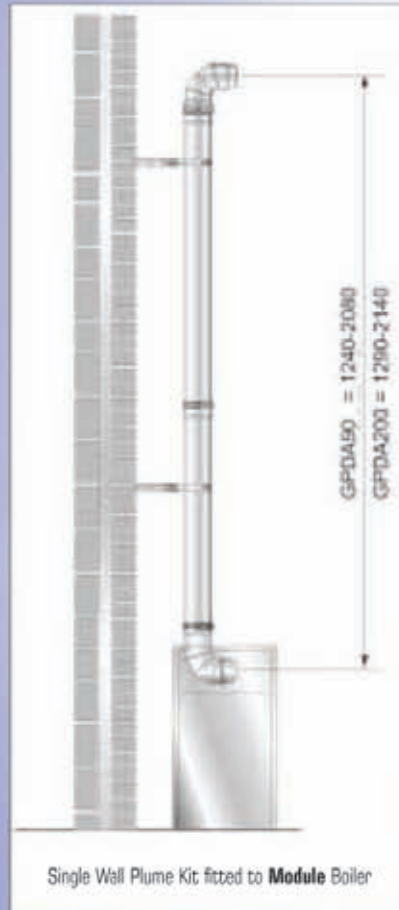
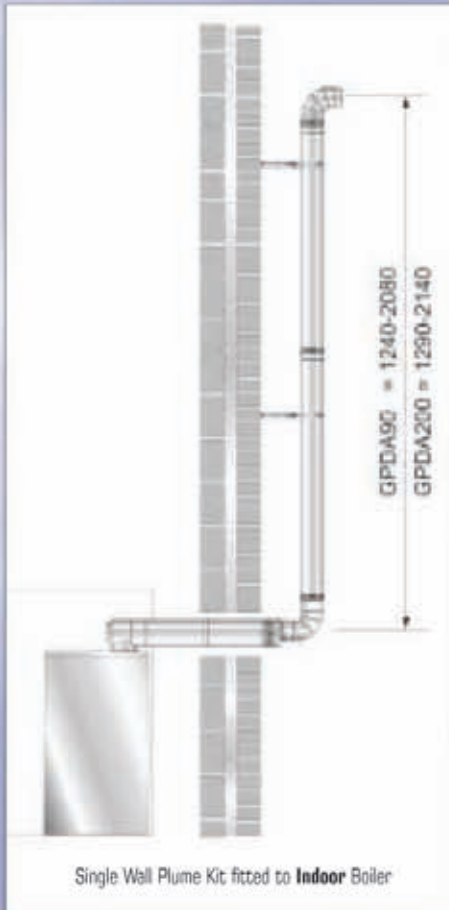

SINGLE WALL FLUE KITS BLUE SYSTEM

Grant Engineering's latest range of flue systems have been developed to make the installation of Grant Boilers quick, simple and to reduce cost, while ensuring trouble free operation – even in the most exposed site conditions.

PLUME DIVERTER KITS

The Grant Plume Kits are available for boilers up to 90,000 BTU (26kW) in 80mm and 120,000 (36kW) and above in 100mm.

The kits come in two forms, a telescopic flue and a 1 metre kit:

| | | |
|-------------------------------|----------------------|------------------------|
| Telescopic flue (2 metres) | GPDA 90IRL | 1240mm - 2080mm |
| | GPDA 200IRL | 1290mm - 2140mm |
| 1 metre kit | GPD901000IRL | (80mm) |
| | GPD2001000IRL | (100mm) |

BOILER HOUSE MODELS

The Grant 'Blue System' is compatible with all Grant Boiler House models. The flue when exiting a boiler house has to pass through a non combustible material, ie. A concrete roof.

COMBUSTION AIR AND VENTILATION

An adequate permanent air supply is required for the safe operation of all open-flued (conventional fuel) oil fired appliances.

This must be in accordance with the requirements of BS5410 Part 1:1997.

Full details of the ventilation requirements for Grant Boilers are given in the instructions provided with every appliance.

OFFSET ELBOWS

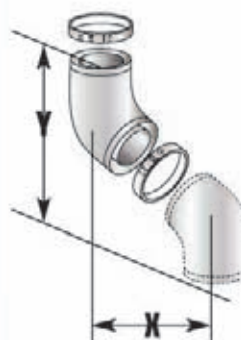

| CODE | X | Y |
|--------------------|------------|------------|
| GPD4590IRL | 115 | 320 |
| GPD45200IRL | 130 | 360 |

45° elbows can be used with the Blue System to offset the flue. Extensions can be used between elbows.

ORDER PART REFERENCE GUIDE

STARTER FLUE KIT BOILER HOUSE ONLY

IMPORTANT

SAFETY INSTALLATION REQUIREMENT FOR FLUE PIPES SERVING OIL FIRED BOILERS DISCHARGING FLUE GAS TEMPERATURES BELOW 250°C. A MINIMUM OF 25MM SEPARATION IS REQUIRED WHERE EXTERNAL SURFACES OF THE FLUE PIPE ARE ADJACENT TO ANY COMBUSTIBLE MATERIAL.



| | | |
|------------------------------|---------------------|-------------------|
| Starter Section | GPD8C 90IRL | Models up to 26kW |
| C/W Test Point 125mm high | GPD8C 200IRL | Models 26 - 70kW |

FLUE EXTENSIONS HIGH LEVEL STAINLESS STEEL (SINGLE SKIN)

IMPORTANT

FLUE EXTENSIONS CANNOT BE CUT.

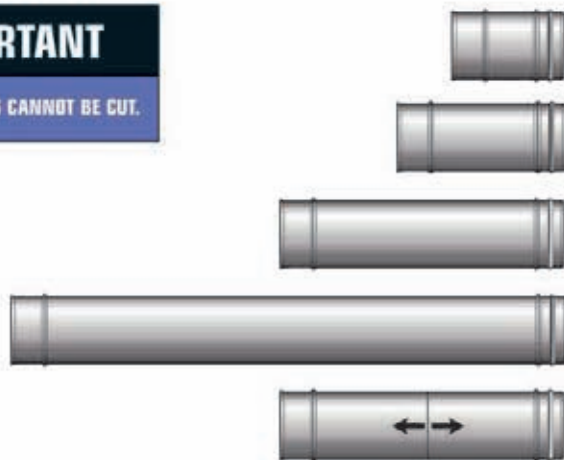

| | | |
|----------------------------|--------------------------|--------------------------------|
| Extension 200mm | GPD200EXT/90IRL | Models up to 26kW ^o |
| C/W Locking Band | GPD200EXT/200IRL | Models 26 - 70kW ^o |
| Extension 250mm | GPD250EXT/90IRL | Models up to 26kW ^o |
| C/W Locking Band | GPD250EXT/200IRL | Models 26 - 70kW ^o |
| Extension 500mm | GPD500EXT/90IRL | Models up to 26kW ^o |
| C/W Locking Band | GPD500EXT/200IRL | Models 26 - 70kW ^o |
| Extension 1000mm | GPD1000EXT/90IRL | Models up to 26kW ^o |
| C/W Locking Band | GPD1000EXT/200IRL | Models 26 - 70kW ^o |
| Adjustable Extension | GPDAP/90IRL | Models up to 26kW ^o |
| 225-295mm C/W Locking Band | GPDAP/200IRL | Models 26 - 70kW ^o |

TERMINALS STAINLESS STEEL

IMPORTANT

DIAMETERS
MODELS UP TO 26kW 80MM
MODELS 26kW-70kW 100MM



| | | |
|-------------------------|---------------------|--------------------------------|
| High Level 90° Terminal | GPDHLT90IRL | Models up to 26kW ^o |
| C/W Locking Band | GPDHLT200IRL | Models 26 - 70kW ^o |
| Vertical Terminal | GPDVT90IRL | Models up to 26kW ^o |
| C/W Locking Band | GPDVT200IRL | Models 26 - 70kW ^o |

ACCESSORIES STAINLESS STEEL

IMPORTANT

VERTICAL FLUE LENGTHS OF UP TO 8 METRES CAN BE ACHIEVED UTILISING EXTENSIONS. MAXIMUM HORIZONTAL LENGTH: UP TO 3M. 45° ELBOWS CAN ALSO BE ACCOMMODATED WITHIN THIS LENGTH (MAXIMUM 2 ELBOWS).



| | | |
|----------------------------|-----------------------|--------------------------------|
| 45° Elbow | GPD45/90IRL | Models up to 26kW ^o |
| C/W Locking Band | GPD45/200IRL | Models 26 - 70kW ^o |
| Wall Bracket 50mm Ext. | GPDWB5090IRL | Models up to 26kW ^o |
| | GPDWB50200IRL | Models 26 - 70kW ^o |
| Wall Bracket 300mm Ext. | GPDWB30090IRL | Models up to 26kW ^o |
| | GPDWB300200IRL | Models 26 - 70kW ^o |

^oFor Euroflame Condensing 90/120 Module use 'Red' version

INTERNAL HIGH LEVEL BALANCED FLUE SYSTEMS

- White Powder Coated -

HIGH LEVEL BALANCED FLUE KITS 'WHITE SYSTEM'

High level balanced flue kits feature the same EZ-Fit boiler connections as the low level flue. The unique clamping system on the high level flue ensures easy assembly thereby reducing installation costs.

FLEXIBLE DESIGN

The kits may be extended horizontally and vertically. It is now possible to create offsets in standard high level flue systems by using our 45° elbows and extension kits – increasing the versatility of this new range.

REDUCES INSTALLATION TIME

The high level kits feature self sealing exhaust ducts and a quick-fit locking band connection for the air duct, which vastly reduces the time taken to complete the installation.

DIMENSIONS

Section 'A' is the starter piece for the flue system and push fits into the boiler connector supplied with the kit. Section 'A' incorporates the air supply spigot and a combustion test point.

Sections 'B' and 'C' combine to form a telescopic length. Terminal section 'E' slides over elbow 'D'. The horizontal length can be extended using the extensions listed. The adjustable extension cannot be connected to the terminal section 'E' – a fixed extension must be used. The vertical height can be extended using the extensions or 45° elbows listed. For short heights sections 'B' and 'C' may be omitted and elbow 'D' fitted to starter section 'A'.

OFFSET ELBOWS

| CODE | X | Y |
|------------|-----|-----|
| ELB K21IRL | 140 | 340 |
| ELB K22IRL | 160 | 385 |

45° elbows can be used with high level kits to offset the flue. Extensions can be used between elbows.

INTERNAL HIGH LEVEL FLUE KIT (WHITE POWDER COATED)

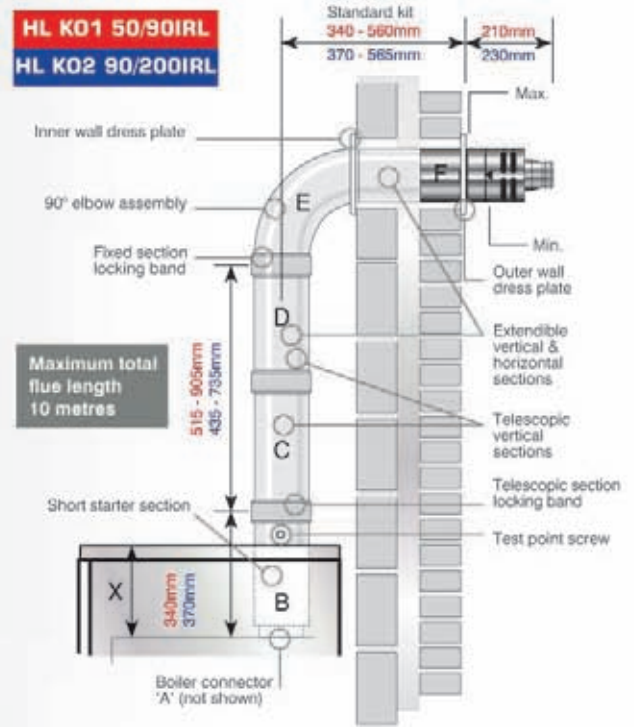

Contents of High Level balanced flue kit:

- Boiler connector A
 - Short starter section B
 - Vertical telescopic section C/D
 - Horizontal telescopic section (inc. terminal) E/F
- Note:** For height adjustment see chart below.
Note: For Boiler House models, air supply kit part No. EZAS is supplied with boiler.

- Locking bands
- Inner seals (red)
- Outer seal (black)
- Boiler connector
- Dress plates (inner & outer)
- Fitting Instructions

HIGH LEVEL BALANCED FLUE HOLE CUTTING DIMENSIONS

| MODEL | DIMENSIONS (mm) | | | | |
|--|-----------------|-------|-------|-------|--------|
| | A dia | B min | C min | C max | D side |
| NON - CONDENSING | | | | | |
| Euroflame Kitchen/Utility models 50/70 | 175 | 1175 | 1675 | 2075 | 85 |
| Euroflame Kitchen/Utility models 50/90 & 50/90 System | 175 | 1227 | 1727 | 2127 | 105 |
| Euroflame Kitchen/Utility models 90/120 & System | 200 | 1237 | 1657 | 1977 | 100 |
| Euroflame Boiler House models 50/70 | 175 | 1203 | 1703 | 2103 | 95 |
| Euroflame Boiler House models 50/90 | 175 | 1230 | 1730 | 2130 | 120 |
| Euroflame Boiler House models 90/120 | 200 | 1278 | 1698 | 2018 | 120 |
| Multi Pass Kitchen & System models 70/90 | 175 | 1203 | 1703 | 2103 | 120 |
| Multi Pass Kitchen & System models 90/140 | 200 | 1450 | 1870 | 2190 | 125 |
| Multi Pass Kitchen models 140/160, 160/200 | 200 | 1562 | 1982 | 2302 | 148 |
| Multi Pass Boiler House models 70/90 | 175 | 1211 | 1711 | 2111 | 145 |
| Multi Pass Boiler House models 90/140 | 200 | 1450 | 1870 | 2190 | 135 |
| Multi Pass Boiler House models 140/160, 160/200 | 200 | 1560 | 1980 | 2300 | 145 |
| Internal Combi Models 90 & Max | 175 | 1200 | 1700 | 2100 | 1100 |
| CONDENSING | | | | | |
| Vortex Kitchen models 50/70 (15-21) | 175 | 1215 | 1715 | 2115 | 115 |
| Vortex Kitchen, Boiler House & System models 50/90 (15-26) | 175 | 1215 | 1715 | 2115 | 115 |
| Vortex Kitchen, Boiler House & System models 90/120 (26-36) & 120/155 (36-46) | 200 | 1280 | 1700 | 2020 | 115 |
| Vortex Kitchen, Boiler House & System models 155/200 (46-58) & 200/240 (58-70) | 200 | 1595 | 2015 | 2335 | 115 |
| Vortex Condensing (internal) Combi model 26 (90) | 175 | 1215 | 1715 | 2115 | 115 |
| Vortex Condensing (internal) Combi model 36 (120) | 200 | 1280 | 1700 | 2020 | 105 |
| Euroflame Condensing Kitchen & Boilerhouse 50/70 (15-21), 50/90 (15-26) | 175 | 1215 | 1715 | 2115 | 115 |
| Euroflame Condensing Kitchen & Boilerhouse 90/120 (26-36) | 200 | 1280 | 1700 | 2020 | 115 |

STANDARD KIT WITH NO EXTENSIONS FITTED.

NOTE: Flue pipe diameter: 150mm 180mm
Excluding locking bands
(SEE DIMENSION 'A' OPPOSITE FOR HOLE SIZE).

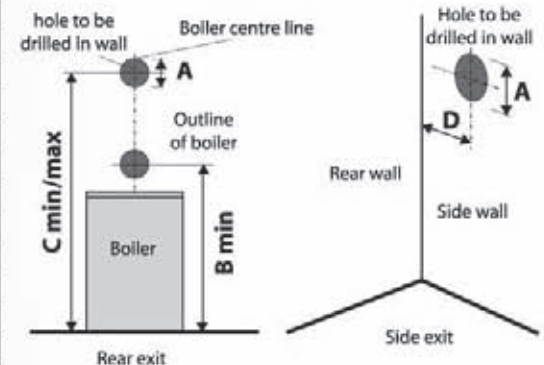

NOTE: B Min = Minimum height with sections 'B' and 'C' removed and is measured from the floor to the centre line of the hole. C Min/Max = Minimum and maximum heights with sections 'A', 'B', 'C', 'D' & 'E' used.

ORDER PART REFERENCE GUIDE

HIGH LEVEL BALANCED FLUE KITS INTERNAL

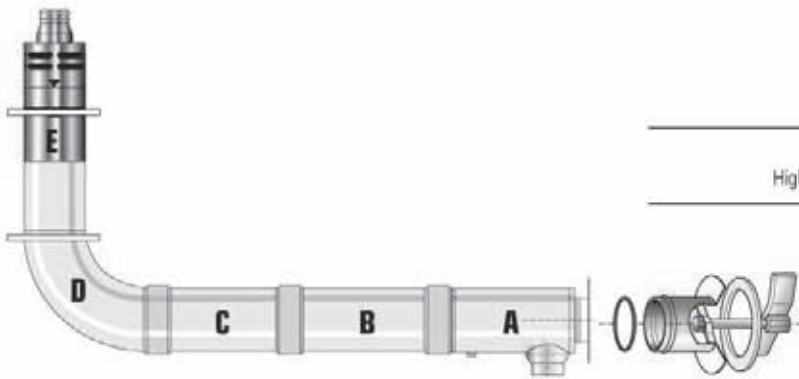

| | | |
|----------------------------------|-------------------------|-------------------|
| 1.2 Metre High Level Flue Kit | HL K01 50/90IRL | Models up to 26kW |
| | HL K02 90/200IRL | Models 26 - 70kW |

HIGH LEVEL BALANCED FLUE EXTENSIONS INTERNAL

IMPORTANT

FLUE EXTENSIONS CANNOT BE CUT. WHITE SYSTEM EXTENSIONS ARE FOR HIGH LEVEL OR VERTICAL INTERNAL USE ONLY AND CANNOT BE USED WITH YELLOW, GREEN OR ORANGE SYSTEM COMPONENTS.



| | | |
|-------------------------------------|---------------------------|-------------------|
| Extension 225mm C/W Locking Band | EXT K31 225/90IRL | Models up to 26kW |
| | EXT K32 225/200IRL | Models 26 - 70kW |



| | | |
|-------------------------------------|---------------------------|-------------------|
| Extension 450mm C/W Locking Band | EXT K09 450/90IRL | Models up to 26kW |
| | EXT K10 450/200IRL | Models 26 - 70kW |



| | | |
|-------------------------------------|---------------------------|-------------------|
| Extension 950mm C/W Locking Band | EXT K11 950/90IRL | Models up to 26kW |
| | EXT K12 950/200IRL | Models 26 - 70kW |



| | | |
|--|---------------------------|-------------------|
| Adjustable Extension 275-450mm C/W Locking Band | EXT K13 ADJ/90IRL | Models up to 26kW |
| | EXT K14 ADJ/200IRL | Models 26 - 70kW |

HIGH LEVEL BALANCED FLUE ACCESSORIES

IMPORTANT

HIGH LEVEL BALANCED FLUES CAN BE EXTENDED TO A MAXIMUM LENGTH OF 4 METRES (6 METRES ON CONDENSING BOILERS) USING THE EXTENSION KITS ILLUSTRATED ABOVE. DEDUCT ONE METRE FOR EACH ADDITIONAL 45° ELBOW USED (MAXIMUM 4 ELBOWS).



| | | |
|-------------------------------|--------------------------|-------------------|
| 45° Elbow C/W locking Band | ELB K21 45/90IRL | Models up to 26kW |
| | ELB K22 45/200IRL | Models 26 - 70kW |

IMPORTANT

A TERMINAL GUARD IS REQUIRED WHEN THE FLUE TERMINATES LESS THAN 2 METRES ABOVE OUTSIDE GROUND LEVEL.

IMPORTANT

WHITE ENAMEL FOR INTERNAL USE ONLY

INTERNAL VERTICAL BALANCED FLUE SYSTEMS

- White Powder Coated -

VERTICAL BALANCED FLUE KITS 'WHITE SYSTEM'

Vertical balanced flue kits share the same EZ-Fit boiler connections as our high level kits. The unique clamping system on the vertical balanced flue ensures easy assembly thereby reducing installation costs.

FLEXIBLE DESIGN

As with our high level kits it is now possible to create offsets in straight flue runs by using our 45° elbows and adjustable extension kits - increasing the versatility of this new range.

MAXIMUM VERTICAL FLUE LENGTH

Vertical balanced flues can be extended to a maximum length of 6 metres on non-condensing boilers and 8 metres on condensing boilers in a straight run using the extension kits illustrated on Page 9. Deduct one metre for each additional 45° elbow used (maximum 4 elbows).

DIMENSIONS

The dimensions shown are measured from top of the boiler spigot, not the boiler case. The distance between the boiler flue spigot and the top of the casing should be taken into consideration. (See boiler installation manual).

Section (A) is the starter piece for the flue system and push fits into the boiler connector supplied with the kit. Section (A) incorporates the air supply spigot and a combustion test point.

Sections (B) and (C) combine to form a telescopic length. Terminal section (E) slides telescopically over fixed length section (D).

For short flue heights section (D) may be omitted and the terminal section (E) may be fitted directly to section (C). The terminal section (E) overlaps section (C) by 50mm. Telescopic adjustment of the flue, if required, is still possible between sections (B and C).

VERTICAL FLUE KIT (WHITE POWDER COATED)

Maximum length
8 metres (10 metres on
condensing boilers)

VT K05 50/90IRL

VT K06 90/200IRL

NOTE: Flue diameters:
150mm 180mm
Excluding locking bands

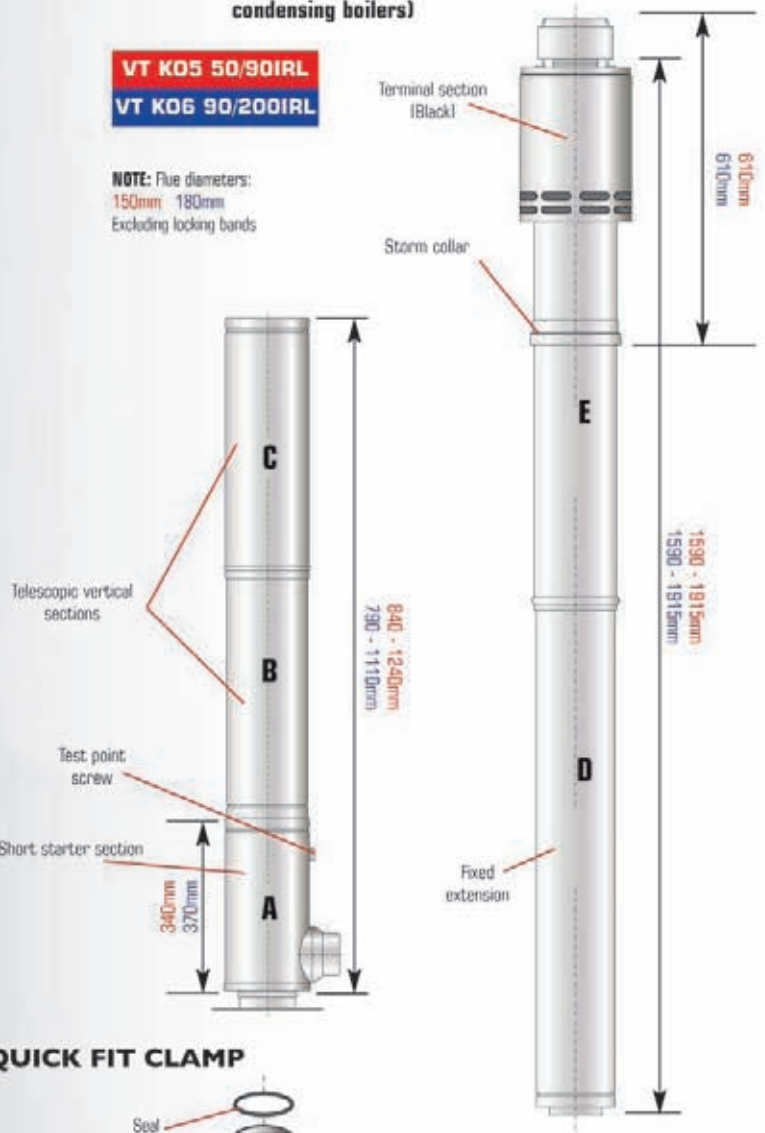

QUICK FIT CLAMP

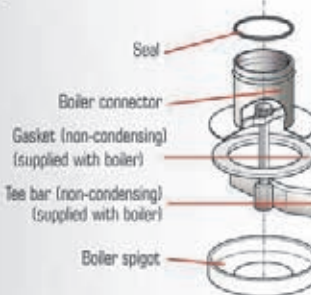

NOTE: Diagram above shows fixing method for non condensing boiler.

Contents of 3 metre vertical balanced flue kit:

- Short starter section A
- Vertical telescopic section B/C
- Fixed section 950mm D
- Terminal section E (inc. storm collar)
- Locking bands (not shown)
- Inner seals (red)
- Boiler connector (w/ clamp)
- Ceiling dress plate (not shown)
- Firestop spacers (not shown)
- Wall bracket
- Fitting instructions

NOTE: For Boiler House models, air supply kit part No. EZAS is supplied with boiler.

OFFSET ELBOWS

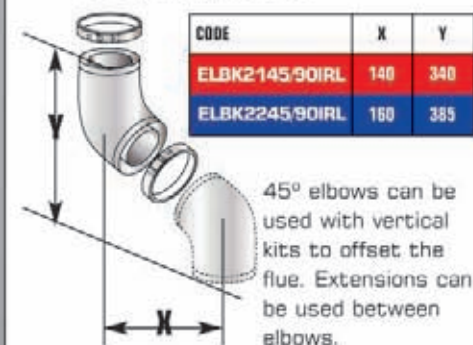

ORDER PART REFERENCE GUIDE

VERTICAL BALANCED FLUE KITS INTERNAL

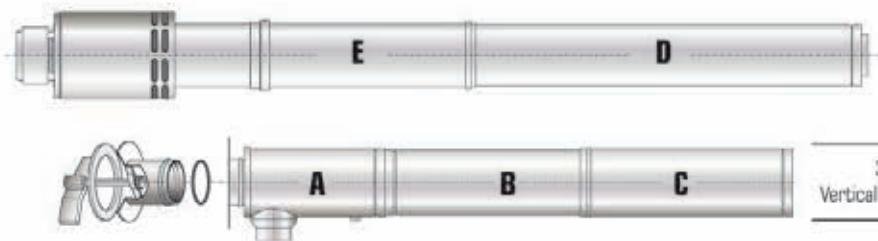

| | | |
|------------------------------|-------------------------|-------------------|
| 3 Metre Vertical Flue Kit | VT K05 50/90IRL | Models up to 26kW |
| | VT K06 90/200IRL | Models 26 - 70kW |

VERTICAL BALANCED FLUE EXTENSIONS INTERNAL

IMPORTANT

FLUE EXTENSIONS CANNOT BE CUT. WHITE SYSTEM EXTENSIONS ARE FOR HIGH LEVEL OR VERTICAL INTERNAL USE ONLY AND CANNOT BE USED WITH YELLOW, GREEN OR ORANGE SYSTEM COMPONENTS.



| | | |
|-------------------------------------|---------------------------|-------------------|
| Extension 225mm C/W Locking Band | EXT K31 225/90IRL | Models up to 26kW |
| | EXT K32 225/200IRL | Models 26 - 70kW |



| | | |
|-------------------------------------|---------------------------|-------------------|
| Extension 450mm C/W Locking Band | EXT K09 450/90IRL | Models up to 26kW |
| | EXT K10 450/200IRL | Models 26 - 70kW |



| | | |
|-------------------------------------|---------------------------|-------------------|
| Extension 950mm C/W Locking Band | EXT K11 950/90IRL | Models up to 26kW |
| | EXT K12 950/200IRL | Models 26 - 70kW |

IMPORTANT

WHITE ENAMEL FOR INTERNAL USE ONLY



| | | |
|--|---------------------------|-------------------|
| Adjustable Extension 275-450mm C/W Locking Band | EXT K13 ADJ/90IRL | Models up to 26kW |
| | EXT K14 ADJ/200IRL | Models 26 - 70kW |

VERTICAL BALANCED FLUE ACCESSORIES



| | | |
|-------------------------------|--------------------------|-------------------|
| 45° Elbow C/W Locking Band | ELB K21 45/90IRL | Models up to 26kW |
| | ELB K22 45/200IRL | Models 26 - 70kW |

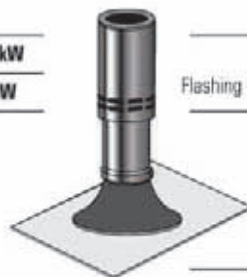

| | | |
|-----------------------------------|-----------------------|-------------------|
| Flat Roof Flashing - Aluminium | VT K27 F90IRL | Models up to 26kW |
| | VT K28 F200IRL | Models 26 - 70kW |

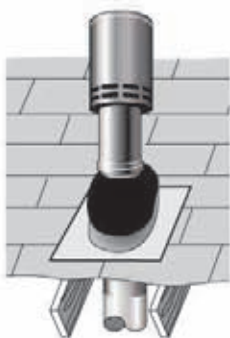

| | | |
|--------------------------------------|---------------------|-------------------|
| Pitched Roof Flashing - Aluminium | VT MF 200IRL | Models up to 70kW |
|--------------------------------------|---------------------|-------------------|

| | | |
|---------------------------------|-----------------------|-------------------|
| Pitched Roof Flashing - Lead | VT K25 P90IRL | Models up to 26kW |
| | VT K26 P200IRL | Models 26 - 70kW |

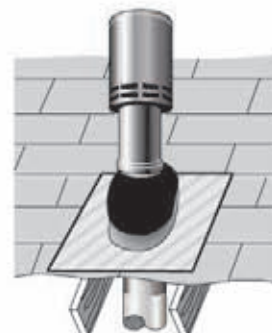

| | | |
|--------------|----------------------|-------------------|
| Wall Bracket | BRK 29 90IRL | Models up to 26kW |
| | BRK 30 200IRL | Models 26 - 70kW |

EXTERNAL LOW LEVEL/HIGH LEVEL/VERTICAL FLUES

- Stainless Steel -

EXTERNAL FLUE SYSTEMS

HIGH LEVEL/VERTICAL EXTERNAL EZ-FIT FLUES 'GREEN SYSTEM'

Grant's range of EZ-Fit Flue Systems have now been extended to include 'external' high level and vertical options, which are fully compatible with most Grant boilers, including our condensing models. These new systems are supplied in a modular form, enabling most installations to be accommodated and are manufactured from high grade stainless steel.

STARTER FLUE KITS (PLUME DIVERTER)

The Starter Flue Kit enables all internal boilers to be connected to an 'external' high level or vertical flue system, whilst maintaining the room sealed operation of the boiler. It is even possible to convert an existing EZ-Fit low level balanced flue kit to an external high level or vertical arrangement without any additional building work. This is particularly useful when plumbing from a low level flue terminal is a nuisance.

STARTER ELBOW

The Starter Elbow converts any of Grant's external modules or module combis to high level or vertical conventional flue operation. The stainless steel flue components are fully insulated, have 'O' ring seals and locking bands, ensuring a rigid construction every time.

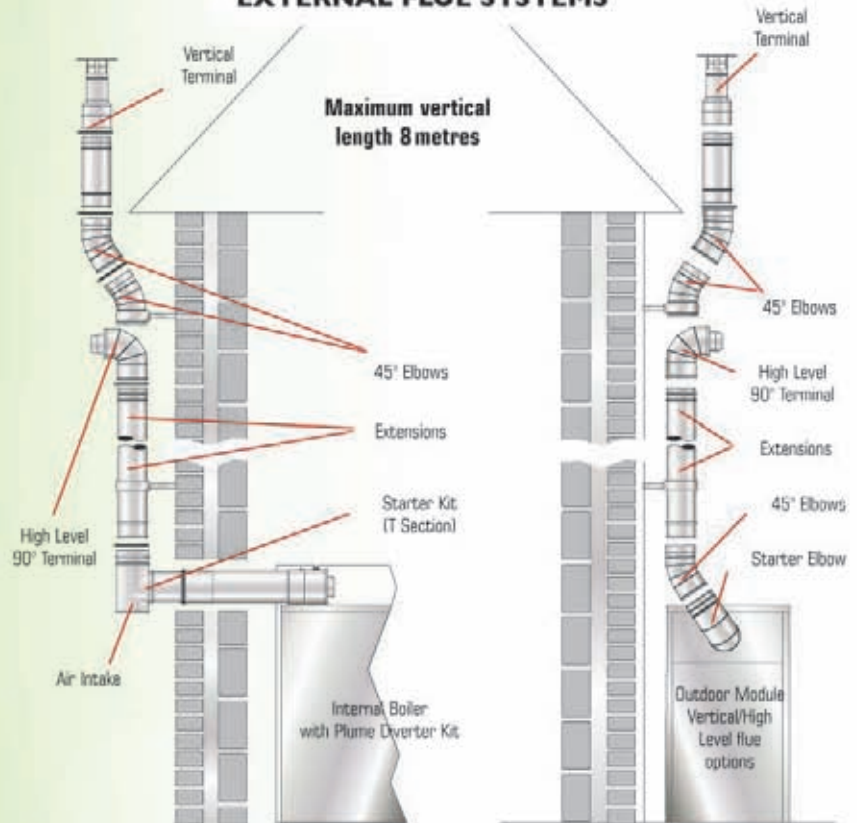

OFFSET ELBOWS

| CODE | X | Y |
|-------------|-----|-----|
| GE45/90IRL | 126 | 304 |
| GE45/200IRL | 142 | 343 |

45° elbows can be used with high level flues to create off-sets. Extensions can be used between elbows.

LOW LEVEL STARTER KITS

Standard Kit 370-550mm 370-550mm

Contents of low level starter kit:
 Boiler connector section
 Tee section
 Side outlet cover trim
 Snorkel clamp (not shown)
 Dress plate
 Fixing clamp and gasket
 Lubricant (not shown)

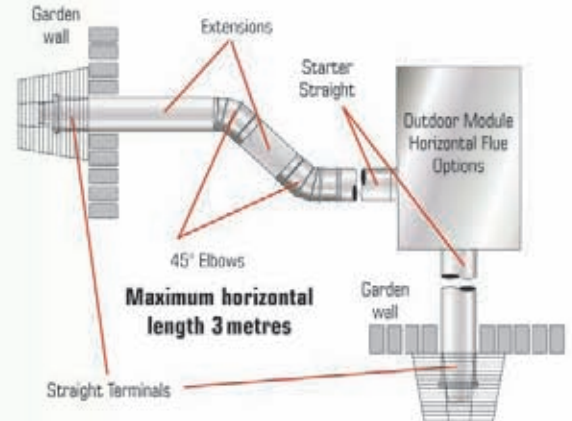

HOLE CUTTING DIMENSIONS

| MODEL | DIMENSIONS (mm) | | |
|--|-----------------|-----|-----|
| | A | B | C |
| Euroflame Kitchen/Utility models 50/70 | 718 | 85 | 127 |
| Euroflame Kitchen/Utility models 50/90 & 50/90 System | 769 | 105 | 127 |
| Euroflame Kitchen/Utility models 90/120 & System | 735 | 115 | 155 |
| Euroflame Boiler House models 50/70 | 748 | 95 | 127 |
| Euroflame Boiler House models 50/90 | 769 | 120 | 127 |
| Euroflame Boiler House models 90/120 | 783 | 126 | 155 |
| Multi Pass Kitchen & System models 70/90 | 756 | 125 | 127 |
| Multi Pass Kitchen & System models 90/140 | 950 | 130 | 162 |
| Multi Pass Kitchen & System models 140/160, 160/200 | 1065 | 155 | 162 |
| Multi Pass Boiler House models 70/90 | 754 | 150 | 127 |
| Multi Pass Boiler House models 90/140 | 948 | 140 | 162 |
| Multi Pass Boiler House models 140/160 & 160/200 | 1063 | 150 | 162 |
| Internal Combi models 90 & Max | 756 | 115 | 127 |
| Vortex Kitchen model 50-70 (15-21) | 768 | 127 | 115 |
| Vortex Kitchen & System models 50-90 (15-26) | 768 | 127 | 115 |
| Vortex Kitchen & System models 90-120 (26-36) & 120-155 (36-46) | 780 | 162 | 115 |
| Vortex Kitchen models 155-200 (46-58) & 200-240 (58-70) | 1105 | 115 | 162 |
| Vortex Condensing (internal) Combi model 26 (90) | 768 | 115 | 127 |
| Vortex Condensing (internal) Combi model 36 (120) | 780 | 105 | 162 |
| Euroflame Condensing Kitchen & Boiler House 50/70 & 70-90 | 768 | 115 | 127 |
| Euroflame Condensing Kitchen & Boiler House 90-120 | 780 | 115 | 162 |

Note: Dimension 'B' is given with the boiler pushed back against the rear wall. Any clearances must be added to 'B'.

Note: Flue diameters:
123mm
152mm

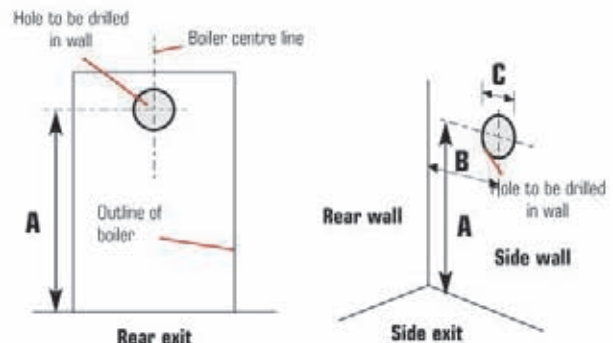

NOTE: Core drill sizes - Models up to 26kW (90,000Btu/h) **127mm**. Remaining models from 26 to 70kW (90-240,000Btu/h) **162mm**.

ORDER PART REFERENCE GUIDE

STARTER FLUE KIT HIGH LEVEL/VERTICAL EXTERNAL

IMPORTANT

STARTER FLUE KITS CAN BE EXTENDED HORIZONTALLY USING EXTENSIONS OR ELBOWS FROM THE LOW LEVEL BALANCED FLUE (YELLOW) SYSTEM ONLY SEE PAGE 3



| | | |
|-------------------|-----------------|-------------------|
| Standard Flue Kit | GK90IRL | Models up to 26kW |
| | GK200IRL | Models 26 - 70kW |

STARTER CONNECTORS OUTDOOR MODULE ONLY - HIGH LEVEL/VERTICAL EXTERNAL



| | | |
|---|-------------------|--------------------|
| Outdoor Module Starter Straight | GKM90CIRL | Models up to 26kW* |
| | GKM200CIRL | Models 26 - 70kW* |
| Outdoor Module Starter Elbow C/W Test Point | GKM90IRL | Models up to 26kW* |
| | GKM200IRL | Models 26 - 70kW* |

FLUE EXTENSIONS HIGH LEVEL/VERTICAL STAINLESS STEEL (DOUBLE SKIN)

IMPORTANT

FLUE EXTENSIONS CANNOT BE CUT. GREEN SYSTEM EXTENSIONS ARE FOR HORIZONTAL OR VERTICAL USE WITH CONVENTIONAL FLUE SYSTEMS ONLY AND CANNOT BE USED WITH YELLOW OR WHITE BALANCED FLUE COMPONENTS.

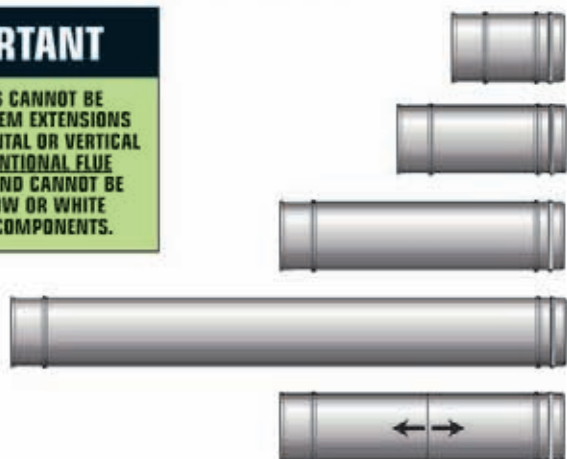

| | | |
|---|----------------------|--------------------|
| Extension 150mm C/W Locking Band | GX150/90IRL | Models up to 26kW* |
| | GX150/200IRL | Models 26 - 70kW* |
| Extension 250mm C/W Locking Band | GX250/90IRL | Models up to 26kW* |
| | GX250/200IRL | Models 26 - 70kW* |
| Extension 450mm C/W Locking Band | GX450/90IRL | Models up to 26kW* |
| | GX450/200IRL | Models 26 - 70kW* |
| Extension 950mm C/W Locking Band | GX950/90IRL | Models up to 26kW* |
| | GX950/200IRL | Models 26 - 70kW* |
| Adjustable Extension 195-270mm C/W Locking Band | GXA250/90IRL | Models up to 26kW* |
| | GXA250/200IRL | Models 26 - 70kW* |

TERMINALS STAINLESS STEEL

IMPORTANT

EXTENSION LENGTHS GIVEN ARE EFFECTIVE LENGTHS IE. WHEN FITTED IN A FLUE SYSTEM.



| | | |
|-------------------------|------------------|--------------------|
| High Level 90° Terminal | GTH90IRL | Models up to 26kW* |
| | GTH200IRL | Models 26 - 70kW* |
| Vertical Terminal | GTV90IRL | Models up to 26kW* |
| | GTV200IRL | Models 26 - 70kW* |
| Straight Terminal Only | GTL90IRL | Models up to 26kW* |
| | GTL200IRL | Models 26 - 70kW* |

ACCESSORIES STAINLESS STEEL

IMPORTANT

VERTICAL FLUE LENGTHS OF UP TO 8 METRES CAN BE ACHIEVED UTILISING EXTENSIONS. 45° ELBOWS CAN ALSO BE ACCOMMODATED WITHIN THIS LENGTH (MAXIMUM 2 ELBOWS).



| | | |
|----------------------------|--------------------|--------------------|
| 45° Elbow C/W Locking Band | GE45/90IRL | Models up to 26kW* |
| | GE45/200IRL | Models 26 - 70kW* |
| Wall Bracket | GWB90IRL | Models up to 26kW* |
| | GWB200IRL | Models 26 - 70kW* |
| Extended Wall Bracket | GEB90IRL | Models up to 26kW* |
| | GEB200IRL | Models 26 - 70kW* |

*For Euroflame Condensing 90/120 Module use 'Red' version

CONVENTIONAL FLUE SYSTEMS - CONDENSING BOILERS ONLY

- Stainless Steel -

CONVENTIONAL FLUES FOR GRANT CONDENSING BOILERS ORANGE SYSTEM

As many older oil fired boilers are traditionally connected to conventional flue systems, updating to a modern condensing boiler often results in the appliance needing to be relocated. The Grant EZ-Fit Conventional Flue System (Orange System) has been specifically designed to enable the existing chimney to be re-used and the boiler retained in its original position.

EZ-FLEXI PACKS

Grant have developed a range of EZ-Fit Flexi Packs containing all the components required to utilise the existing chimney, including a smooth bore stainless steel flue liner, terminal, clamp plate and connectors for both the flex and boiler. All that is required to complete the installation is extension pipes or elbows from our Orange System accessories range.

PLUMING

Condensing boilers operate at extremely high efficiencies with cool flue gas temperatures, resulting in a plume of vapour being visible at the flue terminal. This plumbing (steam) is a normal condition of condensing boilers and indicates that the appliance is working efficiently. As an alternative to a low level, high level, or vertical balanced flue kit, utilising the original chimney with a Grant conventional flue Flexi-Pack moves the plume of vapour above roof level.

COMBUSTION AIR AND VENTILATION

An adequate permanent air supply is required for the safe operation of all open-flued (conventional flue) oil-fired appliances. This must be in accordance with the requirements of BS 5410: Part 1: 1997.

Full details of the ventilation requirements for Grant boilers are given in the instructions provided with every appliance.

RIGID TO FLEXIBLE CONVENTIONAL FLUE SYSTEM

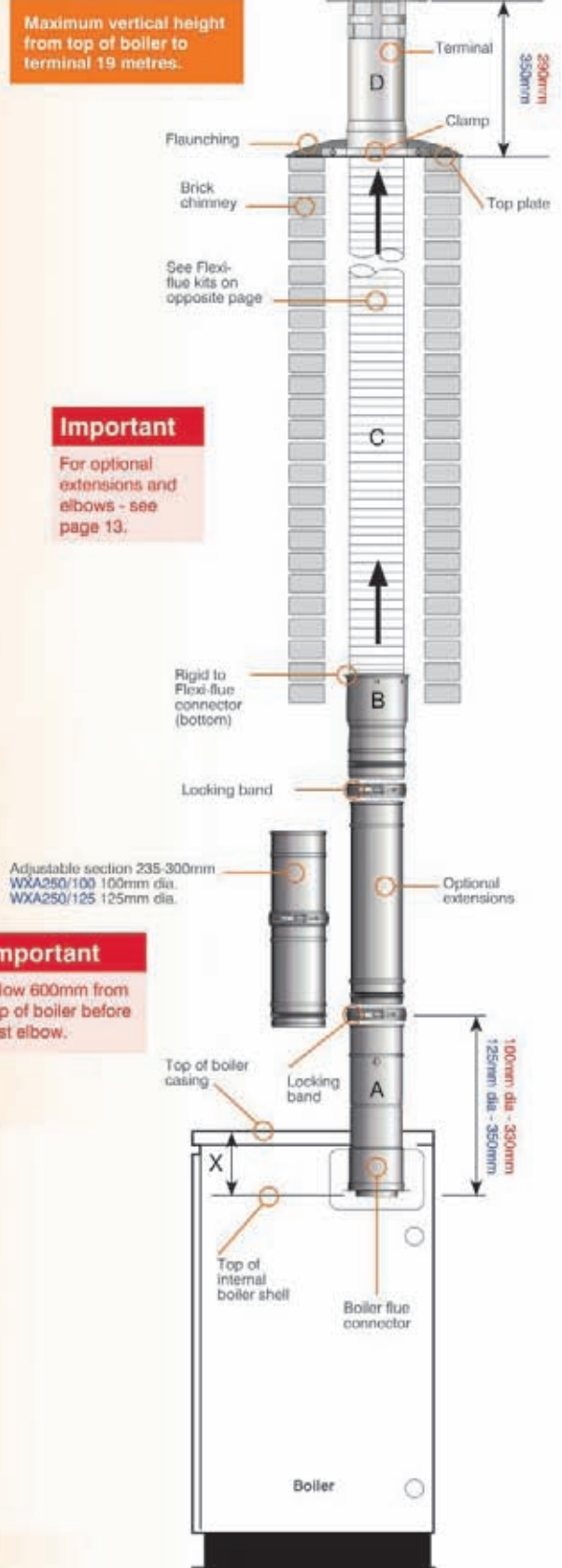

Optional extras

- Rigid extensions
- WX 150/100
 - WX 150/125
 - WX 250/100
 - WX 250/125
 - WX 450/100
 - WX 450/125
 - WX 950/100
 - WX 950/125

- Adjustable extension
235-300mm
- WXA 250/100
 - WXA 250/125

- 45° elbow
- WE 45/100
 - WE 45/125



ORDER PART REFERENCE GUIDE

SMOOTH BORE FLEXI-FLUE KITS STAINLESS STEEL (To suit Grant Condensing boilers only)

Contents of Flexi Flue Kits:

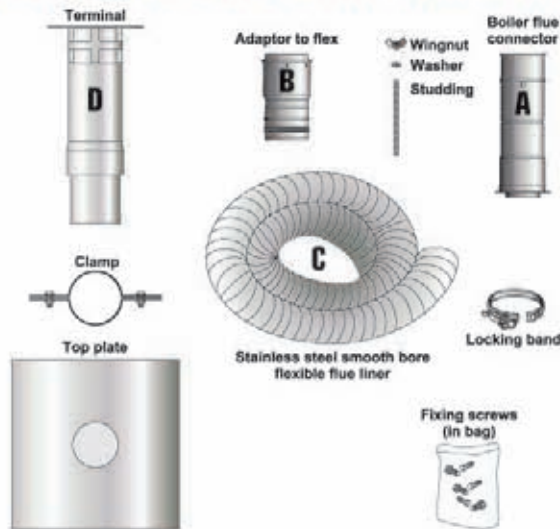

NOTE: Silicone sealant and lubricating grease not shown. For assembly, see diagram on page 10.

| | | |
|----------------------------|-------------------------|-------------------|
| 6 Metre Flexible Flue Kit | GF KIT 6/100IRL | Models up to 46kW |
| | GF KIT 6/125IRL | Models 46 to 70kW |
| 8 Metre Flexible Flue Kit | GF KIT 8/100IRL | Models up to 46kW |
| | GF KIT 8/125IRL | Models 46 to 70kW |
| 10 Metre Flexible Flue Kit | GF KIT 10/100IRL | Models up to 46kW |
| | GF KIT 10/125IRL | Models 46 to 70kW |
| 11 Metre Flexible Flue Kit | GF KIT 11/100IRL | Models up to 46kW |
| | GF KIT 11/125IRL | Models 46 to 70kW |
| 14 Metre Flexible Flue Kit | GF KIT 14/100IRL | Models up to 46kW |
| | GF KIT 14/125IRL | Models 46 to 70kW |

FLUE EXTENSIONS WHITE POWDER COATED (SINGLE SKIN)

IMPORTANT

FLUE EXTENSIONS CANNOT BE CUT. ORANGE SYSTEM EXTENSIONS ARE FOR VERTICAL USE ONLY AND CANNOT BE USED WITH YELLOW OR WHITE SYSTEM COMPONENTS.

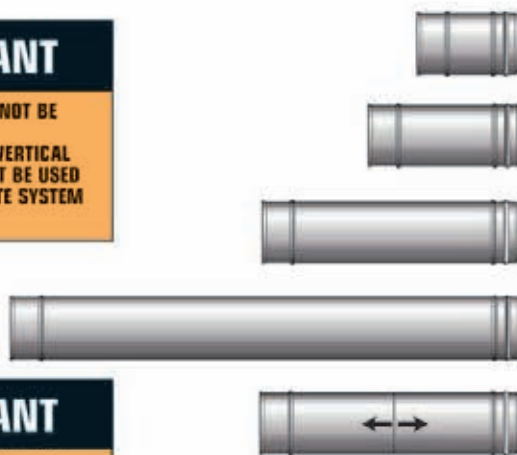

| | | |
|---|-----------------------|-------------------|
| Extension 150mm C/W Locking Band | WX 150/100IRL | Models up to 46kW |
| | WX 150/125IRL* | Models 46 to 70kW |
| Extension 250mm C/W Locking Band | WX 250/100IRL | Models up to 46kW |
| | WX 250/125IRL* | Models 46 to 70kW |
| Extension 450mm C/W Locking Band | WX 450/100IRL | Models up to 46kW |
| | WX 450/125IRL* | Models 46 to 70kW |
| Extension 950mm C/W Locking Band | WX 950/100IRL | Models up to 46kW |
| | WX 950/125IRL* | Models 46 to 70kW |
| Adjustable Extension 235-300mm C/W Locking Band | WXA250/100IRL | Models up to 46kW |
| | WXA250/125IRL* | Models 46 to 70kW |

IMPORTANT

EXTENSION LENGTHS GIVEN ARE EFFECTIVE LENGTHS IE. WHEN FITTED IN A FLUE SYSTEM.

ACCESSORIES WHITE POWDER COATED

IMPORTANT

COMPONENTS FROM THE ORANGE AND GREEN SYSTEM CAN BE USED TO CONSTRUCT INTERNAL HIGH LEVEL, OR VERTICAL CONVENTIONAL FLUE DISCHARGE KITS USING THE FLUE ADAPTOR KIT CFA 15/70 IRL.



| | | |
|-------------------------------|---------------------|-------------------|
| 45° Elbow C/W Locking Band | WE45/100IRL* | Models up to 46kW |
| | WE45/125IRL* | Models 46 to 70kW |

IMPORTANT

WHEREVER POSSIBLE INCORPORATE ONE ADJUSTABLE SECTION

FLEXIBLE VERTICAL BALANCED FLUE SYSTEMS

STAINLESS STEEL INNER AND OUTER LINERS

UNIQUE FLEXI VERTICAL BALANCED FLUE KITS RED SYSTEM

The Grant Red system is the flexible balanced flue solution to nuisance plumbing and cold draughts. It is designed for Grant condensing boilers up to 26kW (90,000Btu/h) and allows an existing masonry chimney to be utilised rather than re-site the boiler and pipework.

RED SYSTEM KITS

The Red system is supplied in two parts: Pack 1 consists of the boiler connector, adjustable extensions, bottom adaptor, terminal, plate and clamp. Pack 2 comprises two lengths of flexible vertical flue pipe and is available in lengths for 6, 8, 10 and 12 metres.

EXTENSIONS AND ELBOWS (FROM WHITE SYSTEM)

The Flexible Vertical balanced flue kits share the same EZ-Fit flue extensions and elbows as the Grant White system. This unique quick fit connection arrangement ensures easy assembly thereby reducing installation costs.

The maximum vertical straight length of the flue, from the top of the boiler to the top of the terminal, is 20 metres – using no more than four 45° elbows.

One metre of straight flue length should be deducted for every elbow used. If the flexible liner has to pass around an offset inside the chimney, two metres of straight flue length should be deducted to compensate for this i.e. equivalent two 45° elbows. Flue extensions cannot be cut, adjustable extensions should be used where required.

MAXIMUM STRAIGHT FLUE LENGTH FROM THE BOILER TO THE TOP OF FLUE TERMINAL = 20 METRES.

NOTE:
Flexi flue pipe diameter:
Inner diameter – 80mm
Outer diameter – 125mm

RIGID TO FLEXIBLE BALANCED FLUE SYSTEM

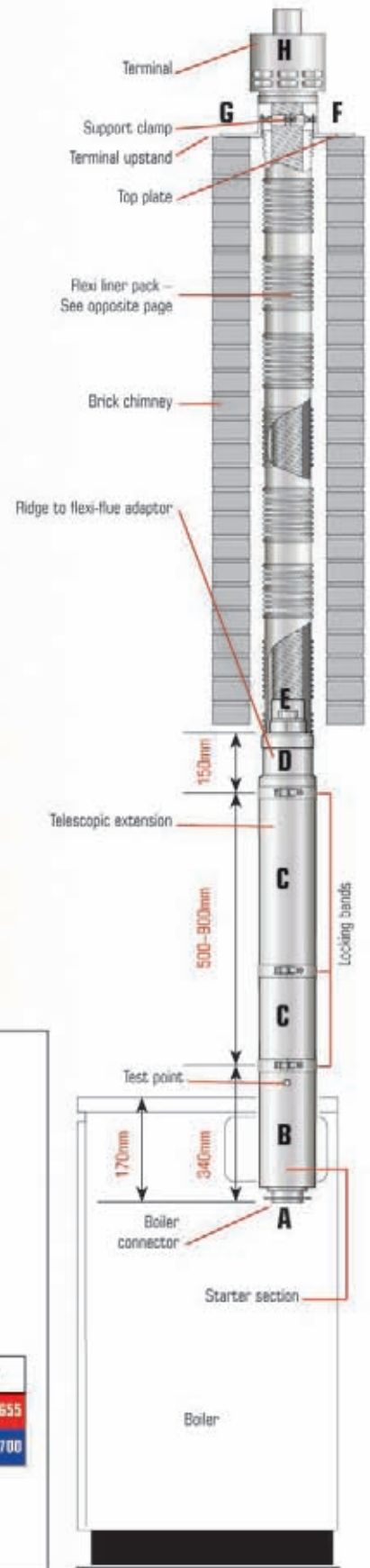

IMPORTANT

THE GRANT RED SYSTEM SHARES EXTENSION PIECES AND ELBOWS FROM THE WHITE SYSTEM.

OPTIONAL EXTRAS (FROM WHITE SYSTEM)



OFFSET ELBOWS

45° elbows can be used with High Level kits to offset the flue. Extensions can be used between elbows.

Elbows directly connected



Elbows connected via fixed extensions



Elbows connected via adjustable extension

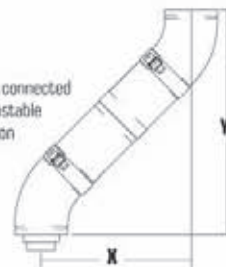

| CODE | X | Y |
|---------|-----|-----|
| ELB K21 | 140 | 340 |
| ELB K22 | 160 | 385 |

| CODE | EXTENSION | X | Y |
|---------|-----------|-----|------|
| ELB K21 | EXT225 | 300 | 500 |
| | EXT450 | 455 | 665 |
| | EXT950 | 810 | 1010 |
| ELB K22 | EXT225 | 320 | 545 |
| | EXT450 | 475 | 700 |
| | EXT950 | 830 | 1055 |

| CODE | X | Y |
|---------|---------|---------|
| ELB K21 | 335-455 | 535-655 |
| ELB K22 | 355-475 | 580-700 |

ORDER PART REFERENCE GUIDE

PACK 1 FLEXI VERTICAL BALANCED FLUE CONNECTOR

NOTE: Longer Flexi balanced flue liner kits are available by special order. Liners are directional and should be installed with the arrows facing upwards.

| | | |
|---------------------------|------------------------|-------------------|
| Red system connector pack | GFX CON KIT/26° | Models up to 26kW |
|---------------------------|------------------------|-------------------|

IMPORTANT

RED SYSTEM KIT COMPRISES PACK 1 & PACK 2 IN REQUIRED LENGTH.

~4 week lead time

PACK 2 FLEXI VERTICAL BALANCED FLUE LINER



~4 week lead time

| | | |
|------------------------------|----------------------|-------------------|
| 6 metre Flexible liner pack | GFX BF 6/26° | Models up to 26kW |
| 8 metre Flexible liner pack | GFX BF 8/26° | Models up to 26kW |
| 10 metre Flexible liner pack | GFX BF 10/26° | Models up to 26kW |
| 12 metre Flexible liner pack | GFX BF 12/26° | Models up to 26kW |

RIGID FLUE EXTENSIONS & ELBOWS (FROM WHITE SYSTEM)

IMPORTANT

FLUE EXTENSIONS CANNOT BE CUT. WHITE SYSTEM EXTENSIONS ARE FOR HIGH LEVEL, VERTICAL AND RED SYSTEM INTERNAL USE ONLY AND CANNOT BE USED WITH YELLOW, GREEN OR ORANGE SYSTEM COMPONENTS.

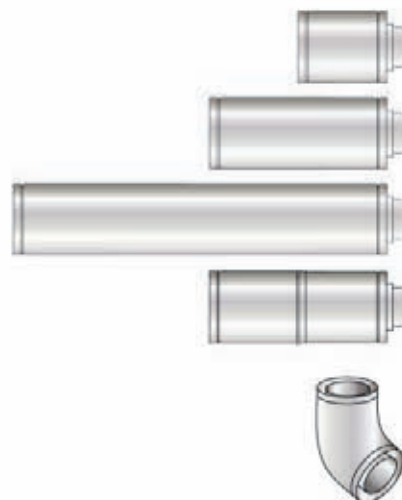

| | | |
|---|-----------------------|-------------------|
| Extension 225mm C/W locking band | EXT K31 225/90 | Models up to 26kW |
| Extension 450mm C/W locking band | EXT K09 450/90 | Models up to 26kW |
| Extension 950mm C/W locking band | EXT K11 950/90 | Models up to 26kW |
| Adjustable extension 275-450mm C/W locking band | EXT K13 ADJ/90 | Models up to 26kW |
| 45° elbow C/W locking band | ELB K21 45/90 | Models up to 26kW |

CLEARANCE FOR BALANCED FLUES



| Ref | Position | mm |
|-----|---|-------------------|
| A | Below a gutter or sanitary pipework | ¹ 600 |
| B | Horizontally from a door | 600 |
| C | Above ground or balcony level | 300 |
| D | Below eaves or balcony (without protection) | ¹ 600 |
| E | From internal or external corner | ² 300 |
| F | From a terminal facing a terminal | 1200 |
| G | From a surface facing a terminal | 600 |
| H | Vertical from terminals on the same wall | 1500 |
| I | Horizontal from terminals on the same wall | ³ 750 |
| J | Below an opening, airbrick, window etc. | 600 |
| K | From vertical sanitary pipework | 300 |
| L | Vertical flue from wall | 750 |
| M | Terminal from oil tank | ⁴ 1800 |

Note 1: 75mm with protection • **Note 2:** 600mm for Outdoor Modules
Note 3: Only applies if one or both terminals are balanced flues.
Note 4: In ROI appliance has to be 1800mm from oil tank

Distance measured to rim of terminal. Clearances advised by Grant Engineering (Ireland) Ltd. in accordance with Building Regulations. The Terminal should be positioned so as to avoid products of combustion accumulating in stagnant pockets around the building or entering into buildings. Care should also be taken that the plume from a condensing flue does not cause a nuisance.

1. An opening means an openable element, such as a window, or a permanent opening such as a permanently open air vent.
2. Notwithstanding the dimensions given, a terminal should be at least 300mm from combustible material, eg. a window frame.
3. A way of providing protection of combustible material would be to fit a heat shield at least 750mm wide.

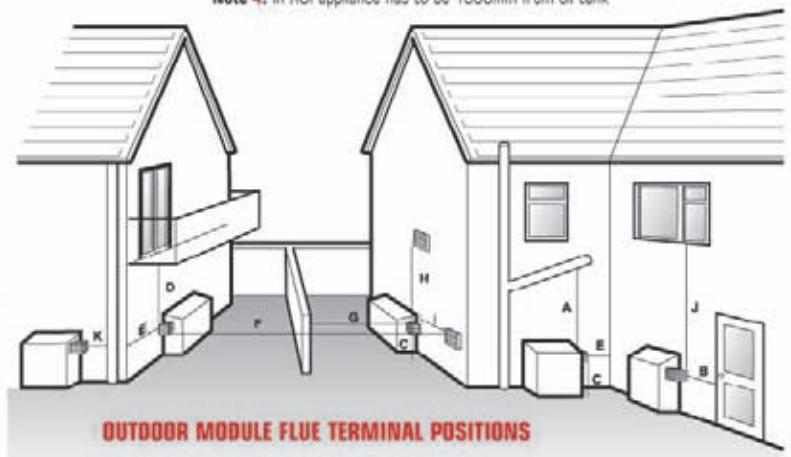

OUTDOOR MODULE FLUE TERMINAL POSITIONS

This brochure is accurate at the time of printing but as Grant has a policy of continual improvement it may be superseded. We reserve the right to amend specifications without prior notice. The statutory rights of the consumer are not affected.

All products manufactured under I.S. EN ISO 9001.

™THE GRANT 'EZ-FIT FLUE' SYSTEM is a Trade Mark of Grant Engineering Limited. ©Grant Vortex, Euroflame and Multi Pass are registered trade marks of Grant Engineering Limited. The contents of this leaflet are fully protected by copyright and nothing may be reproduced without permission from Grant Engineering (Ireland) Ltd.



Available from Grant Engineering



Grant Condensing Oil Boiler Range



Grant Wood Pellet Boiler Range



Grant Solar Solutions and Cylinders Range



Grant Aeronas³ Air Source Heat Pump Range



Grant VortexAir Oil Hybrid Range



Grant EZ-Fit Flue Systems



Grant Back Boilers



GRANT ENGINEERING IRELAND
 Crinkle, Birr, Co. Offaly, Ireland
 T: (057) 9120089 F: (057) 9121060
 E: info@grant.eu
www.grantengineering.ie

NORTHERN IRELAND
 Unit 117, 21 Botanic Avenue
 Belfast BT7 1JJ, Northern Ireland
FREEPHONE : 0800 2794796
 E: info@grantni.com

